

# Durst DA 900

A precision professional enlarger with automatic focusing for two lenses

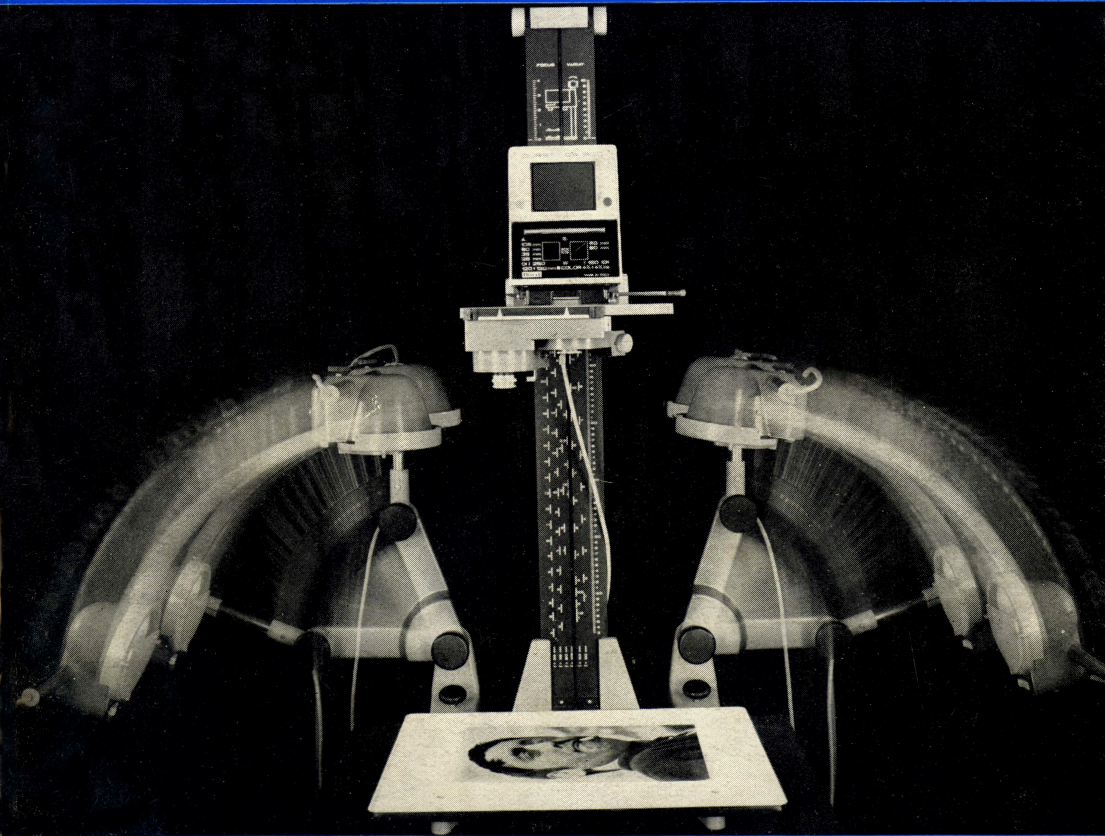

**OPERATING INSTRUCTIONS**

# SPECIFICATION OF COMPONENTS AND OPERATING KNOBS

Serial number	Description	Page
1)	Base	2
2)	Projection board	2
3)	Hexagonal screws for fixing the column in the base	2
4)	Column	2
5)	Enlarger head	2
6)	Filter drawer	2
7)	Mirror housing	2
8)	DANOCON 50 twin condenser	2
9)	DANOCON 105 twin condenser	2
10)	DUONEG negative carrier	2
11)	AUTONEG negative carrier	2
12)	Lenses with their lens board	2
13)	Serial number plate	3
14)	Angular bar on column	3
15)	Lock of the quick-locking lens holder	3
16)	Lens carrier	3
17)	Cable with plug and switch	4
18)	Cover of the light hood	5
19)	Fixing screws for AUTOCALO	4
20)	Red filter wheel-grip	5
21)	Shutter wheel-grip	6
22)	Grip bar for opening the serial number plate	6
23)	Condenser grip (DANOCON 50)	6
24)	Hooks on the condenser mounting	6
25)	Condenser fixing bar	6
26)	Pushing-bar for changing the lenses	6
27)	Lamp socket	6
28)	Wheel-grip for vertical adjustment of the enlarger head	7
29)	Locking screw for the enlarger head adjustment	7
30)	Guide tracks for the heat absorbing filter	4
31) - 32)	Wheel-grip for focusing both the lenses	10
33)	Lens carriage	14
34)	Focus variator wheel-grip	14
35)	Locking knob of focus variator	15
36)	Cross-slot screws on the base board	18
37)	Green filter	19
38)	Steel bands	20

## **DURST DA 900**

A precision professional enlarger for all negative formats up to  $2\frac{1}{2} \times 3\frac{1}{2}$ " (6.5 x 9 cm.) including 70 mm. film; lens range from  $f = 28$  mm. up to  $f = 105$  mm. with automatic focusing for two lenses.

In purchasing the DURST DA 900 you have demonstrated your confidence in our equipment. We are very grateful for this. At the same time we feel it our duty to help and advise you as completely as possible so that you may obtain full use of the extreme versatility of your DURST Da 900. The effortless operation and perfect function of this high capacity enlarger ensure you many years of undisturbed pleasure in your darkroom work.

This manual gives you step by step instructions on the assembly and operation of your DURST enlarger. It is definitely important to read it to learn quickly all of the functions and operating controls of your new enlarger, in order to avoid unintentional damage which could effect your guarantee rights.

**We thank you  
for your  
confidence**

## Lens equipment of the automatic focusing system

The DURST DA 900 comes as ordered with two lenses in the focal lengths of either 28 mm. + 50 mm., 75 mm + 50 mm., 80 mm. + 50 mm., or 105 mm. + 50 mm. mounted into the automatic focusing system. The lenses must not be replaced or exchanged with others, as this would require a readjustment of the automatic focusing system.

## Unpacking

For shipping purposes the enlarger is disassembled as follows:

1 - Base (1) with attached projection board (2) and 4 hexagonal screws (3);

2 - Column (4) with enlarger head (5);

3 - In a separate accessories cardboard box:

Mirror housing (7);

DANOFI filter drawer (6);

DANOCON 50 twin condenser (8) for the lens combination  $f = 28$  mm. + 50 mm. or DANOCON 105 twin condenser (9) for all other lens combinations;

DUONEG negative carrier (10) complete with DUMA 17 R, 18, 26, 35 masks and DUOMO 17 R, 18, 26, 35 counter-masks for the 28 mm. + 50 mm. unit and AUTONEG (11) for all other combinations;

2 lenses with corresponding lens boards (12).

**While unpacking, make sure that you grasp the column (4) and not the steel bands (38)!**

Packing material dust is to be removed from all parts and the lenses, the condenser and the negative carrier glasses should be cleaned with a soft brush or lint-free cloth.

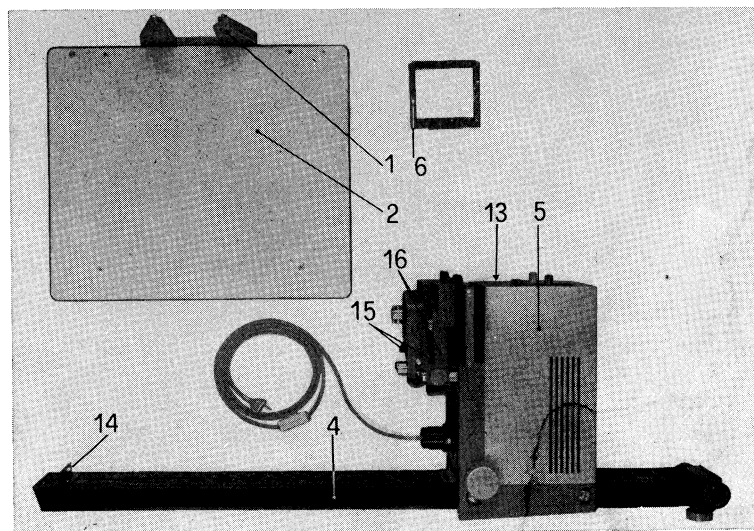

The serial numbers of the lenses are engraved upon the serial number plate (13) of the enlarger. The negative carrier also has the number of the enlarger engraved upon it. Should the numbers differ, return specifying exactly the serial numbers.

**Check the serial numbers of the lens and negative carrier**

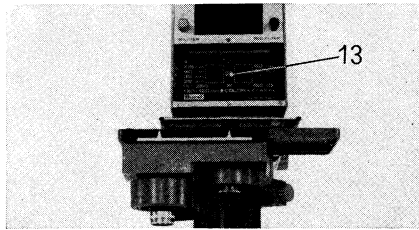
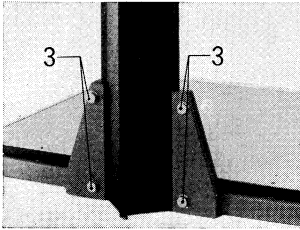

The column (4) with the enlarger head (5) is inserted into the base (1) from above and fastened evenly by means of the four hexagonal screws (3). Make certain that the angular bar (14) on the front side of the column (4) is in perfect contact with the base board (2), as otherwise the focusing plane will not coincide exactly with that of the projection board (2). Only after this has been done may you remove the cord! The lenses are mounted with the enlarger head (5) in its lowest position. To mount them, the lock (15) of the quick-locking lens holder for the respective lenses is pressed to the rear and the lenses with the lens board (12) are mounted into the lens barrel. Then the lock (15) is released, so that the lens is now firmly seated. While mounting the lenses, make certain that the marking upon the respective lens board (12) matches with that of the lens carrier (16) and that the lens is seated properly in its cone.

**Assembly**

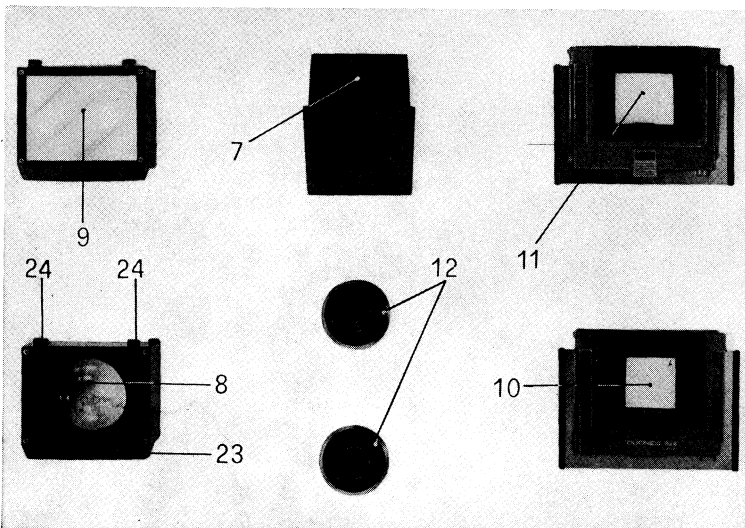

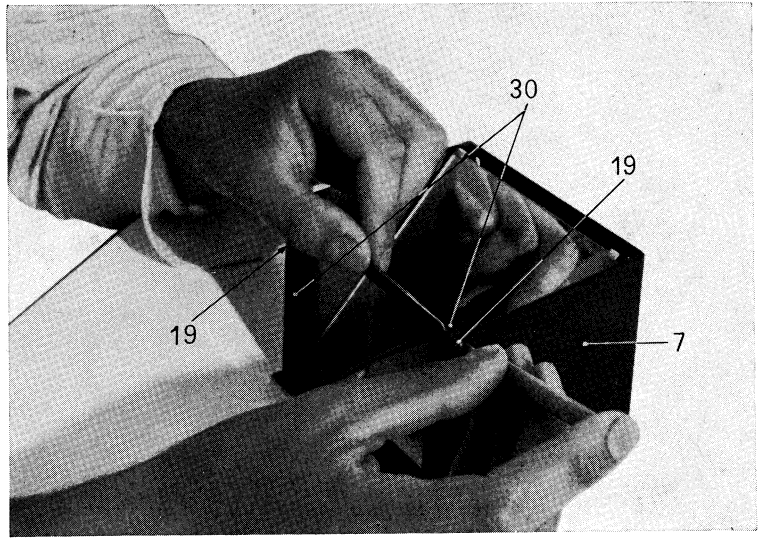

## Illumination

### 1. Light sources

As a rule, the most brilliant, brightest and best illumination for most negatives is obtained by the combination of an opal lamp and a twin condenser. Normally opal lamps of up to 150 W. are used, although also a 250 W. opal lamp may be used. To avoid intense heat, the AUTOCALO heat absorbing filter can be ordered separately and installed. It consists of 2 pieces in a positioning frame. AUTOCALO is inserted over the hereto provided guide tracks (30) into the mirror housing and fixed with both the screws (19).

Every opal lamp should be checked before use (glass defects or dark spots in the bulb may be seen by holding the lamp up against a strong light). During frequent current fluctuations and after long use, combustion deposits are formed which lead to uneven illumination. For this reason the lamps should be checked from time to time. After more than 50 hours of use the opal lamps are no longer suitable for colour work.

The cable (17) with plug and switch pending from the enlarger head (5) is for connection to the mains. After removing the cover of the

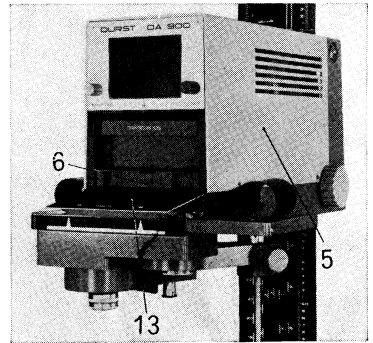
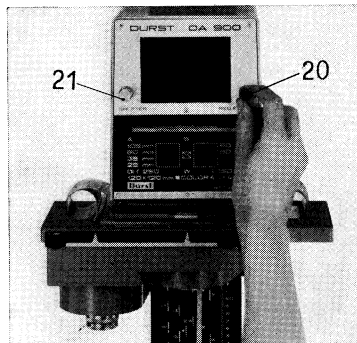

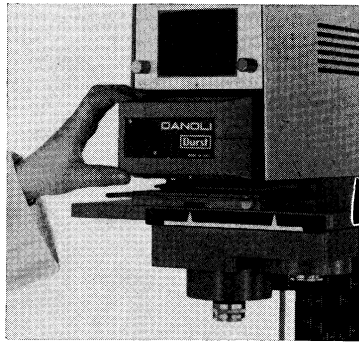
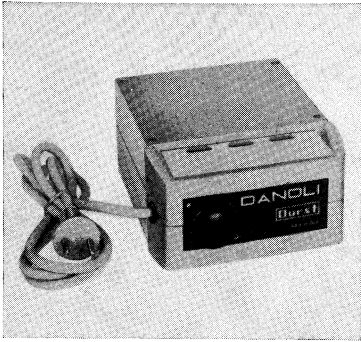

light hood (18), the lamp is screwed into its socket. Do not allow the opal lamp to burn needlessly. Expose only with the light switch or a connected exposure timer.

If you already have the photographic paper upon the projection board and wish to match up the projected picture with the paper format again, swing in at the wheel-grip (20) the red filter which is located above the negative carrier.

Instead of the opal lamp, for black-and-white photography you can also use the DANOLI cold-light unit which has a built-in transformer. With its diffusion soft type lighting it is mainly suitable for work with hard negatives or for the enlargement of pictures where absolute sharpness is not desired. The DANOLI unit with its built-in transformer and orange filter is inserted as follows into the enlarger head (5): remove the serial number plate (13) after having unscrewed the two lateral screws. Then draw out the twin condenser and the filter drawer (6). Now the DANOLI unit can be inserted into the condenser drawer.

The DURST DA 900 can also be used with mercury vapour lamps. As these lamps are of slow ignition, i.e. they need a warming up

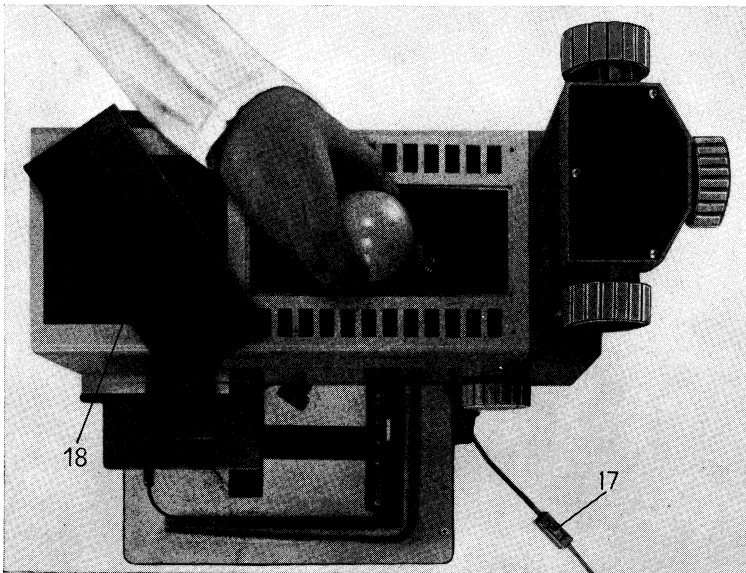

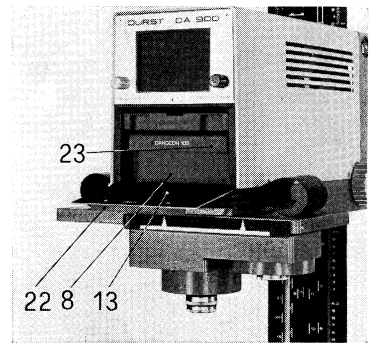
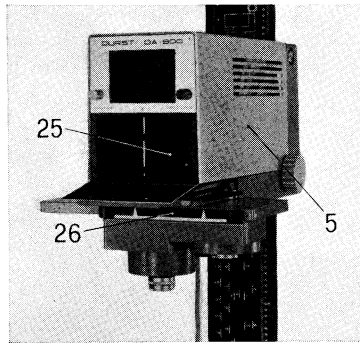

period after having been switched off, they are let burning while in use. Exposure is carried out by means of a built-in shutter which is manipulated at the wheel-grip (21).

## 2. Condenser for the 28/50 mm. lens combination

The DANOCON 50 condenser (8) is slid in behind the serial number plate (13). To do this the serial number plate (13) is opened by drawing it down with the grip bar (22). Take the twin condenser by its grip (23) and insert it upwards so that the two hooks (24) at the rear of the condenser mounting hang upon the bar (25) which adjusts the height of the condenser when the lens is changed. To check if the condenser (8) is properly seated, push the pushing bar (26) for changing the lens to the left until its stop, so that the lens with the long focal length is brought into the path of beams. While doing this the twin condenser (8) should move downwards. After you have mounted the DANOCON 50 twin condenser (8), the enlarger head (5) is brought to its uppermost position and the lamp switched on without a negative in the carrier. With one of the two lenses in the path of beams and open diaphragm, centre the lamp by turning or adjusting vertically as well as forwards and backwards the lamp socket (27) until the projected picture is completely and evenly illuminated.

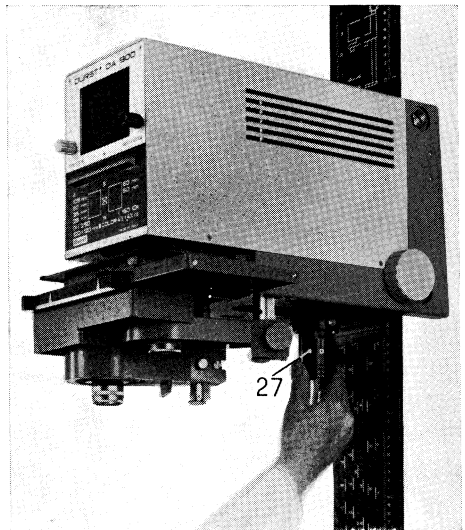
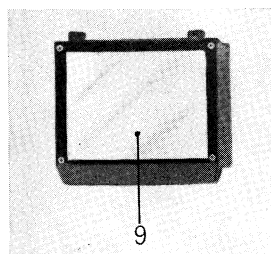
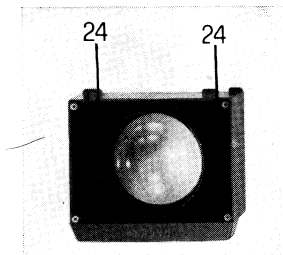



### 3. Condenser for 75/50 mm., 80/50 mm., and 105/50 mm. combinations

The DANOCON 105 twin condenser (9) is mounted into the enlarger head in the same manner as described in section « 2 » for the DANOCON 50. To check if the condenser is seated properly, do the opposite of the test for the DANOCON 50.

Raising the enlarger head (5) causes enlargement and lowering it causes reduction of the projected picture. By turning the wheel-grip (28) in a clockwise direction the enlarger head (5) is raised; turning it counterclockwise lowers the enlarger head (5). Quick and easy movement of the enlarger head (5) in both directions is performed by a simple grasp with one hand. To do this, first disengage the wheel-grip (28) forwards and upwards to phase out the friction drive. Make certain that the locking screw (29) on the left side of the enlarger head (5) is loose. With this screw the enlarger head (5) may be

**Setting  
the enlargement  
format**

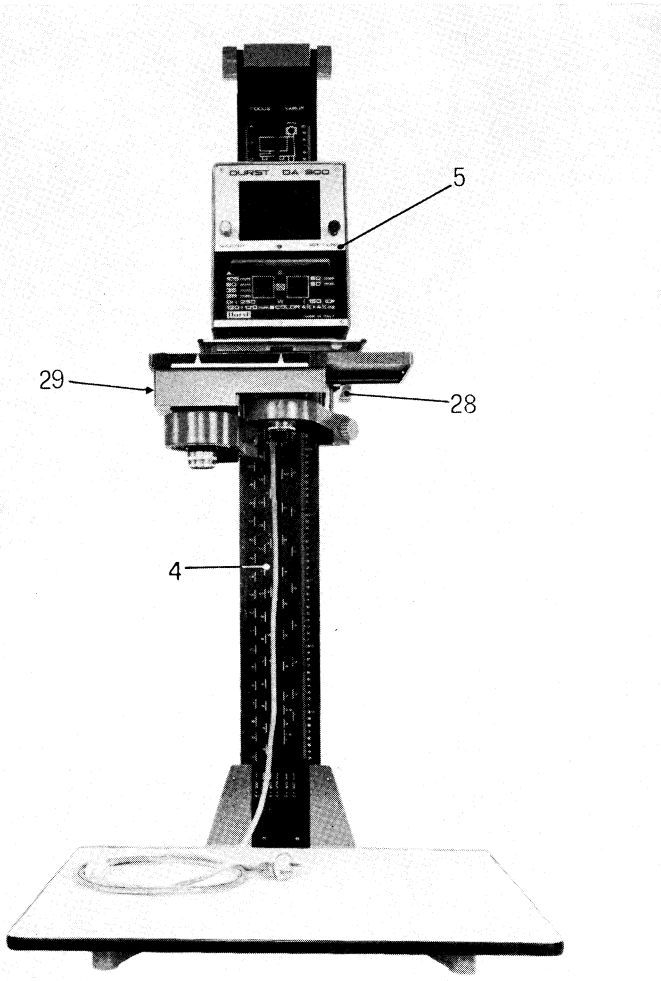

locked in position upon the column (4) as necessary, for instance, for series enlargements.

### Enlargement range

The shorter the focal length, the larger the range of the magnification factors which can be obtained with the DURST DA 900. Here we give exact information on the individual lens focal lengths:

- f = 105 mm., (for negatives up to 2½ x 3½" (6.5 x 9 cm.))
  - automatic from 1.4 up to 6.8 x lin. appr.
  - floor projection up to 14.6 x lin. appr.
  - (with manual adjustment)
- f = 80 mm., (for negatives up to 2¼" sq. (6 x 6 cm.))
  - automatic from 1.3 up to 9.9 x lin. appr.
  - floor projection up to 21 x lin. appr.
  - (with manual adjustment)
- f = 75 mm., (for negatives up to 2¼" (6 x 6 cm.))
  - automatic from 1.2 up to 10.1 x lin. appr.
  - floor projection up to 21.3 x lin. appr.
  - (with manual adjustment)
- f = 50 mm., (for negatives up to 35 mm. (24 x 36 mm.))
  - automatic from 1.9 up to 16.4 x lin. appr.
  - floor projection up to 33 x lin. appr.
  - (with manual adjustment)
- f = 28 mm., (for negatives up to ¾" x 1" (18 x 24 mm.))
  - automatic from 3.3 up to 30.5 x lin. appr.
  - floor projection up to 60 x lin. appr.
  - (with manual adjustment)

These linear magnification factors for the respective enlarger head positions can be read off of scales which are located on the enlarger column (4) for the focal lengths: f = 28 mm., 75/80 mm., 105 mm. and 50 mm. In order to make it possible to return the enlarger head (5) back to the same exact position for later enlargements, a metrical scale is also located on the column (4).

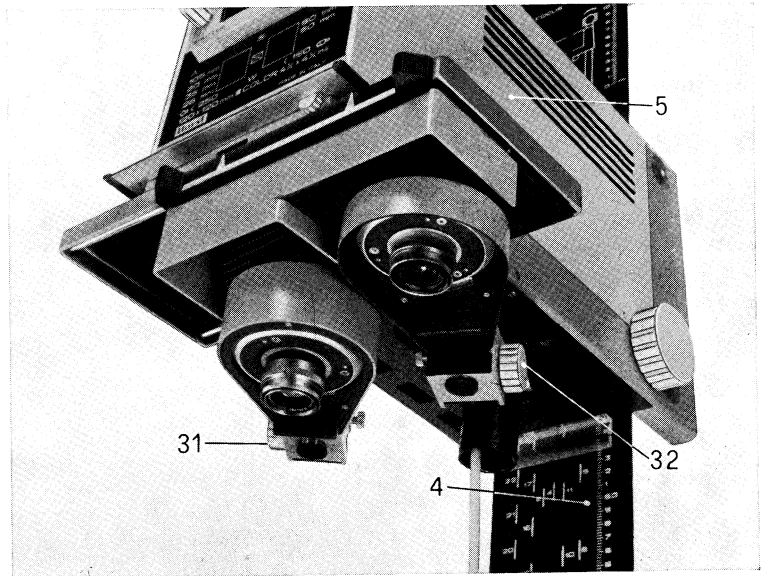

If the enlargement format of the projection board (2) proves insufficient, you can also project upon the floor. In the section « Setting the enlarger format » on page 7 you will find corresponding information on floor projection in the list giving the linear magnification factors. To project upon the floor, loosen the four hexagonal screws (3), turn the enlarger head (5) with the column (4) 180° and insert it into the

## Giant enlargements

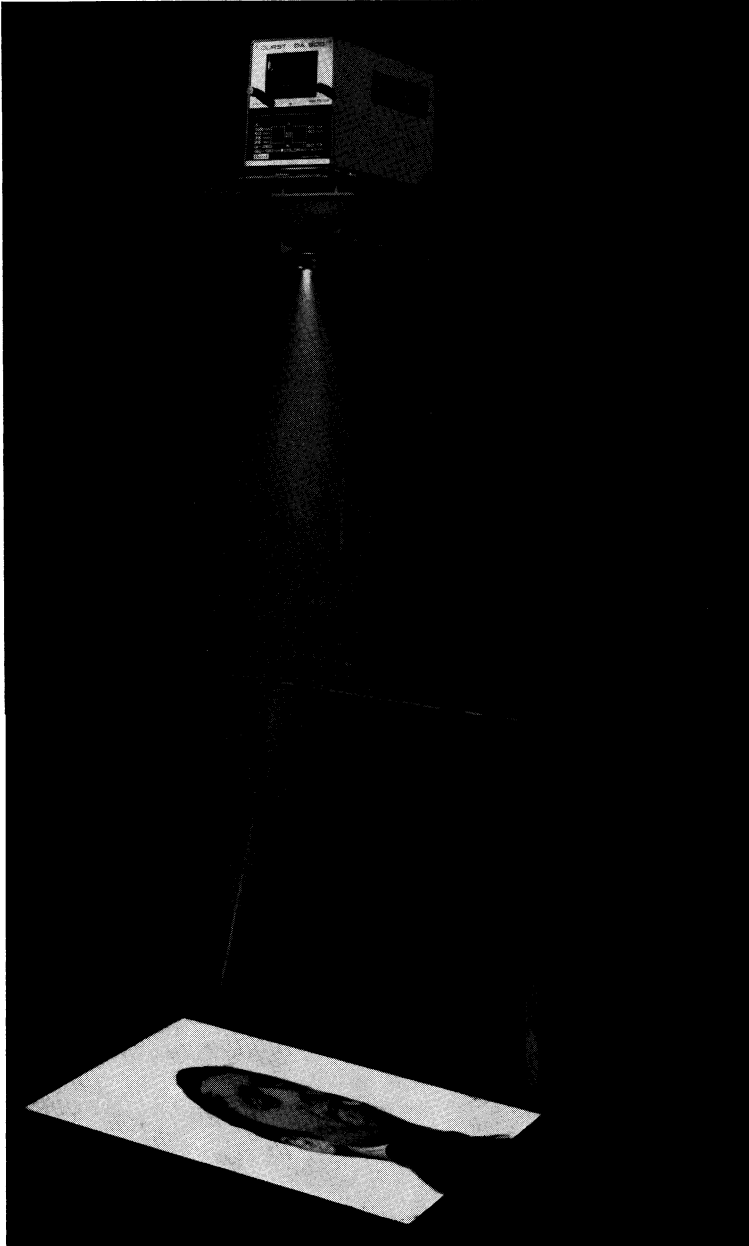

base (1). Do not forget to weight down the projection board (2) to prevent the enlarger from tipping over. During floor projection focus by hand operating the wheel-grips (31 and 32) for the adjustment of the lens bellows. If the automatic focusing is required again, the lens bellows must be locked again in the correct position.

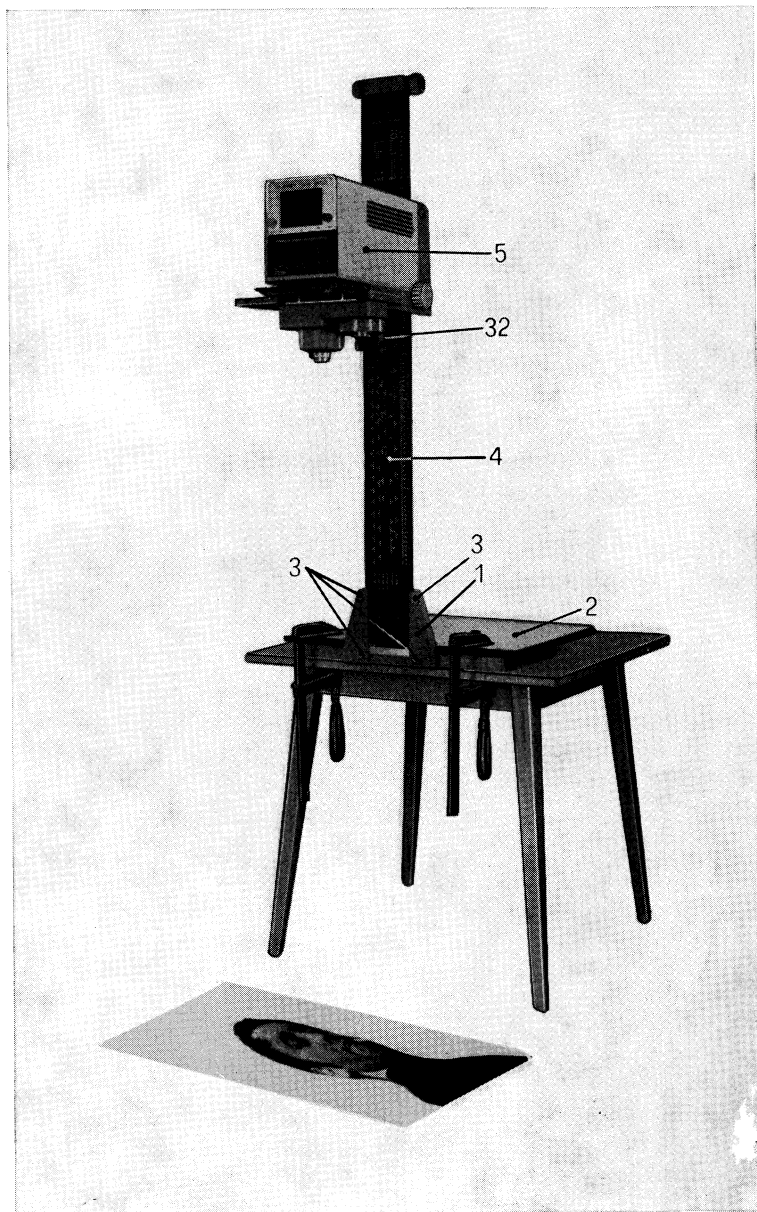

In case the minimum enlargement with the lenses delivered from the factory is insufficient (with manual focusing), the reduction range of the DURST DA 900 can be increased virtually without limit by means of the special accessory extension tubes DUTUB and DUTUB II, so that it is unnecessary to give a list of reduction factors.

## Reductions

### Mounting the DUTUB extension tube

Remove the lens together with its lens board (12) and mount the DUTUB extension tube in its place into the enlarger head (5). Now the lens can be mounted into the DUTUB and focused by means of its knurled outer ring. The focus is fixed with the knurled locking screw upon the DUTUB extension tube. As the mark on the lens board (12) or the diaphragm index mark must be exactly at the front, it may be necessary to loosen the DUTUB lens retaining screw to bring the lens into its proper position (then do not forget to tighten the screw again!).

### DUTUB II lens extension tube for reductions and macrophotography

If greater reductions are desired than possible with the DUTUB, then use the DUTUB II extension tube, which is also suitable for macrophotography. It is mounted into the enlarger head (5) in the same manner as the DUTUB extension tube.



DUTUB I

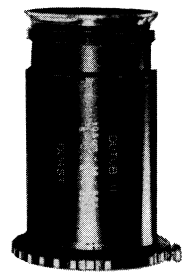

DUTUB II

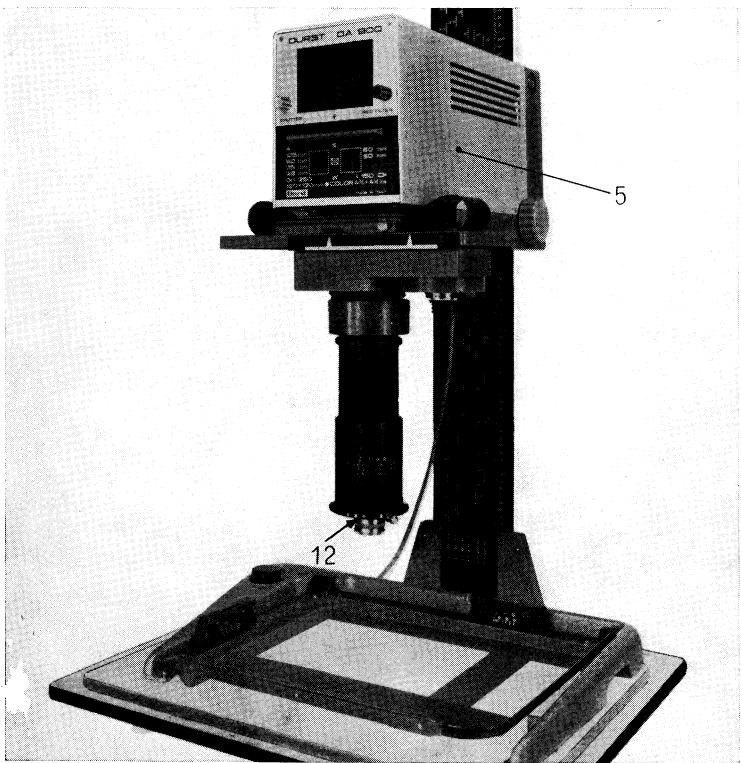

## Inserting the negatives

If negative strips are used, you need not remove the negative carrier: simply press the tension lever (a) and slide the film in at the side with the emulsion side facing down; then let the tension lever (a) loose, thereby pressing the film strip flat. To advance the film, press the lever (a) again. If single negatives are used, on the contrary remove the negative carrier from the enlarger head.

In the DURST DA 900 the following negative carriers may be used, of which one is delivered with the enlarger, according to the lens combination ordered, as standard equipment, whereas the other is available as an extra accessory.

### 1. AUTONEG negative carrier for all negatives up to 2½ x 3½" (6.5 x 9 cm.) including 70 mm. film.

The AUTONEG negative carrier is delivered as standard equipment when the enlarger is equipped with the following lens combinations: 105 mm. + 50 mm., 80 mm. + 50 mm., or 75 mm. + 50 mm. adjustable by pairs. The AUTONEG negative carrier is equipped with masks which can be set to the desired format or to the desired section by turning the knurled knobs (b). In the tilting section of the AUTONEG negative carrier a threaded pin (c) is located on the left- and right-hand sides to adjust the opening between the upper and lower sections of the negative carrier. Single negatives are inserted by removing the negative carrier and placing the negative between the single negative retaining spring (d) and the lower glass plate. The retaining spring can be slid back and forth for the different film sizes.

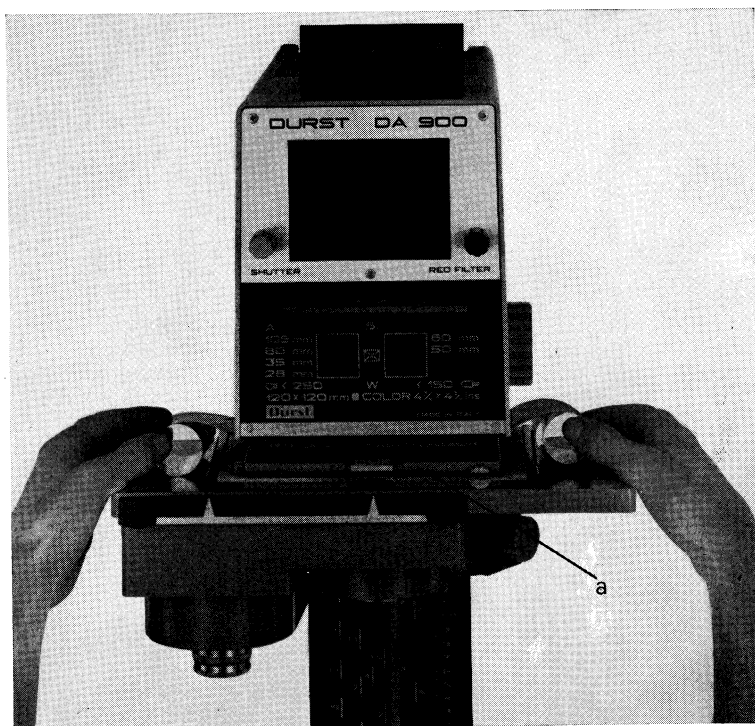

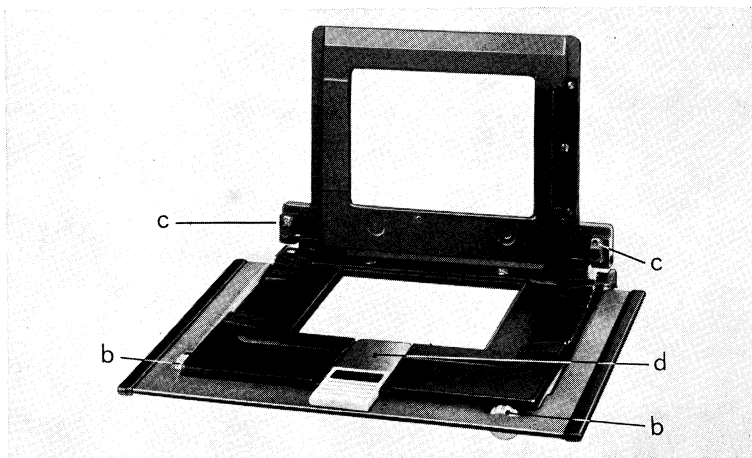

AUTONEG

To avoid Newton rings, the upper glass plate in the AUTONEG negative carrier can be replaced by a special glass plate with anti-Newton rings coating (COSIGLAS OAN) or a glass-free DUOMA mask which comes in the formats: 12 x 17 mm. (1/2 x 11/16") Rollei, 3/4 x 1" (18 x 24 mm.), 11/16" sq. (26 x 26 mm.), 35 mm. (24 x 36 mm.), and 2 1/4" sq. (6 x 6 cm.) and is available as a separate accessory. For this the upper glass plate in the tilting section is drawn out at the front.

## 2. DUONEG negative carrier

The DUONEG negative carrier is for enlarging the formats 12 x 17 mm. (1/2 x 11/16") Rollei, 3/4 x 1" (18 x 24 mm.), 1 1/16" sq. (26 x 26 mm.), 35 mm. (24 x 36 mm.) and 2 1/4" sq. (6 x 6 cm.) completely without glass. For this purpose the DUMA mask for below and the DUOMA mask for above are available separately. The DUONEG negative carrier is inserted into the enlarger head with the opening lever (a) in horizontal position. By turning the knurled knob (b) on the right-hand front side the negative carrier is fixed immovably in the enlarger head. In the tilting section of the DUONEG negative carrier a threaded

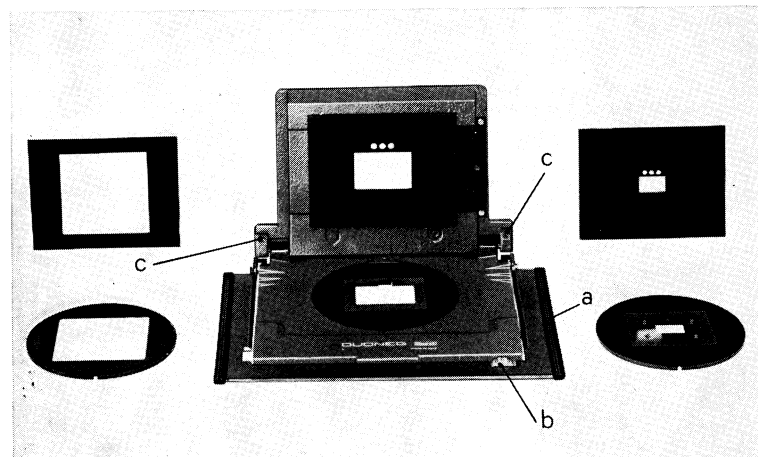

DUONEG

pin is located on the left- and right-hand sides to adjust the opening distance between the upper and lower sections of the negative carrier. If the enlarger is equipped with lenses of 28 and 50 mm., the DUONEG negative carrier is delivered as standard equipment and that complete with the DUMA masks for the following negative formats: 12 x 17 mm. (1/2 x 11/16") Rollei, 3/4 x 1" (18 x 24 mm.), 1 1/16" sq. (26 x 26 mm.) and 35 mm. (24 x 36 mm.).

### Enlarging plates

To enlarge 1 3/4 x 2 1/4" (4.5 x 6 cm.) and 2 1/2 x 3 1/2" (6.5 x 9 cm.) plates the specially designed URAN plate holder is available as a separate accessory. The format inserts of this holder allow the enlargement even of wet plate negatives. The negative plane of the URAN plate holder can be adjusted to the focusing plane of the automatic focusing system so that the plate holder may also be used with the automatic focusing system. To match up the focusing planes of the plate holder and of the automatic focusing system, project a test negative upon the projection board, at best with the enlarger head in its uppermost position. If the test negative appears unsharp, adjust the height of the plate holder by turning its knurled focusing ring (a) either to the left or to the right. This is then locked with the screw (b) and the URAN plate holder is adjusted once for all.

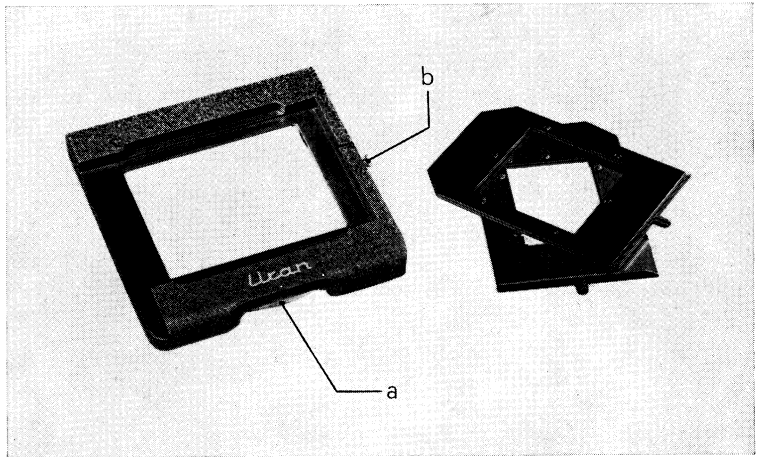

URAN

### Automatic focusing system

The DURST DA 900 focuses automatically with the lenses which have been adjusted at the factory. The movable lens carriage (33) must be locked in the exact position, otherwise the automatic focusing system does not function. The lenses are changed by grasping the pushing-bar (26) and never by grasping the lens tubes themselves. The lenses are adjusted to their utmost sharpness of focus. For this reason, do not loosen the screws of the lens boards (12) or of the lenses themselves.

### Focus variator

If you desire to move the focusing plane to a point higher than the plane of the projection board, it is possible to raise the focusing plane up to 10 cm. (4") by means of the focus variator wheel-grips (34). This is necessary when the enlarging paper (for instance, while



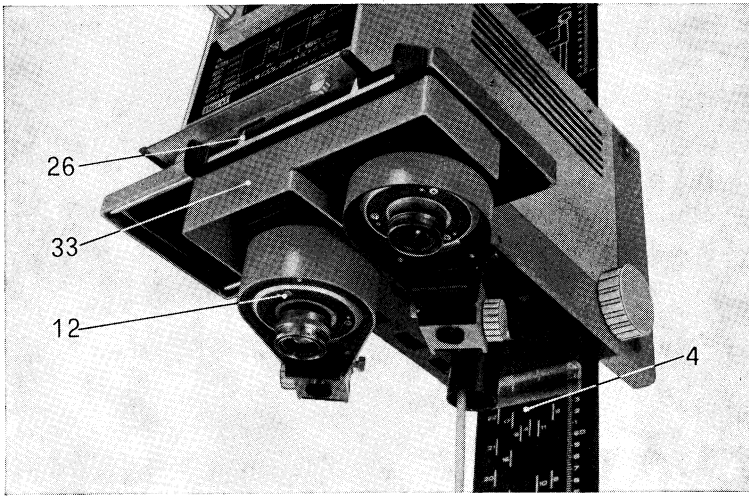

using so-called automatic exposure easels, etc.) is not in direct contact with the base board (2). The locking knob (35) located at the rear at the same height as the focus variator wheel-grips arrests the steel band and thereby holds the focusing plane in position. This can be read off on the scale upon the enlarger column (4). If you desire to enlarge directly upon the projection board (2) again, be sure not to forget to return the focus variator wheel-grips back to their original position, as otherwise out-of-focus pictures will result. To do this, loosen the locking knob (35) slowly and gently brake the return of the focus variator with the hand.

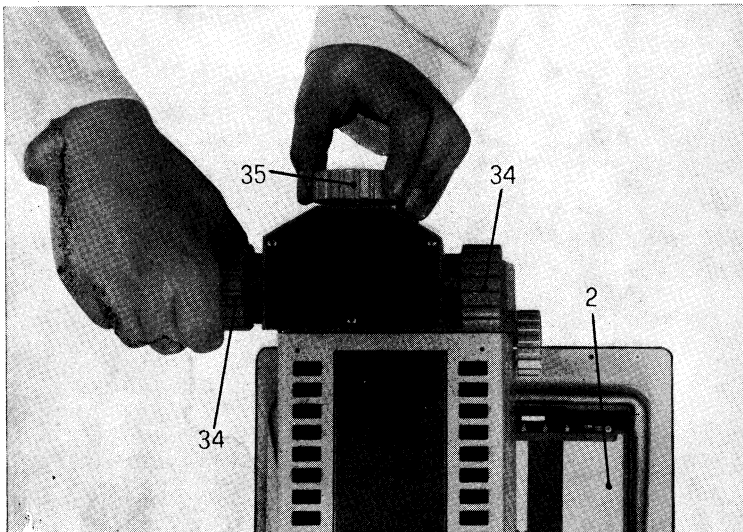

## Manual adjustment

If the automatic focusing does not suffice at close range, it is possible to focus additionally by hand with the wheel-grips (31 and 32) for adjusting the lens bellows.

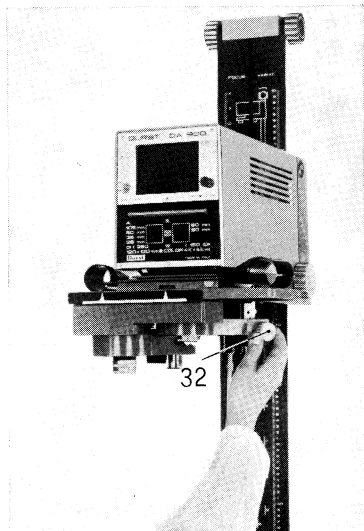
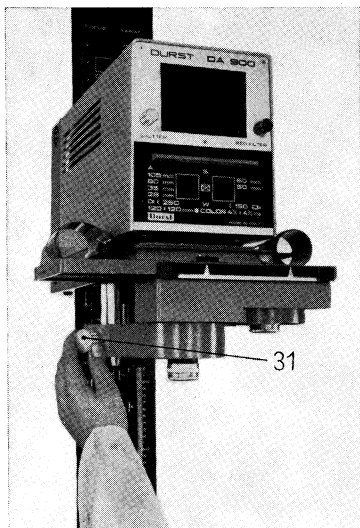

## Colour enlargements

For colour enlargements, colour filters in 12 x 12 cm. (4 $\frac{3}{4}$ " sq.) format may be placed in the DANOFI filter drawer (6). Depending upon the focal length of the lens being used, the DANOFI filter drawer is inserted either above or below the condenser so as not to prevent condenser vertical adjustment.

**IMPORTANT:** The DANOFI filter drawer should only be left in the condenser compartment in case it gets used.

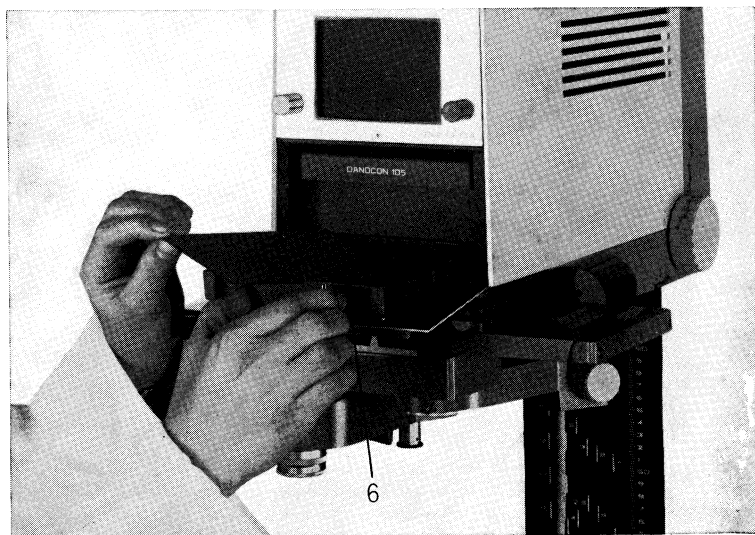

In addition the DURST DA 900 can be fitted with a colour mixing head. For this the AUTOFARB adapter is required. This special accessory is fastened to the enlarger head by means of the four screws which are delivered with it.

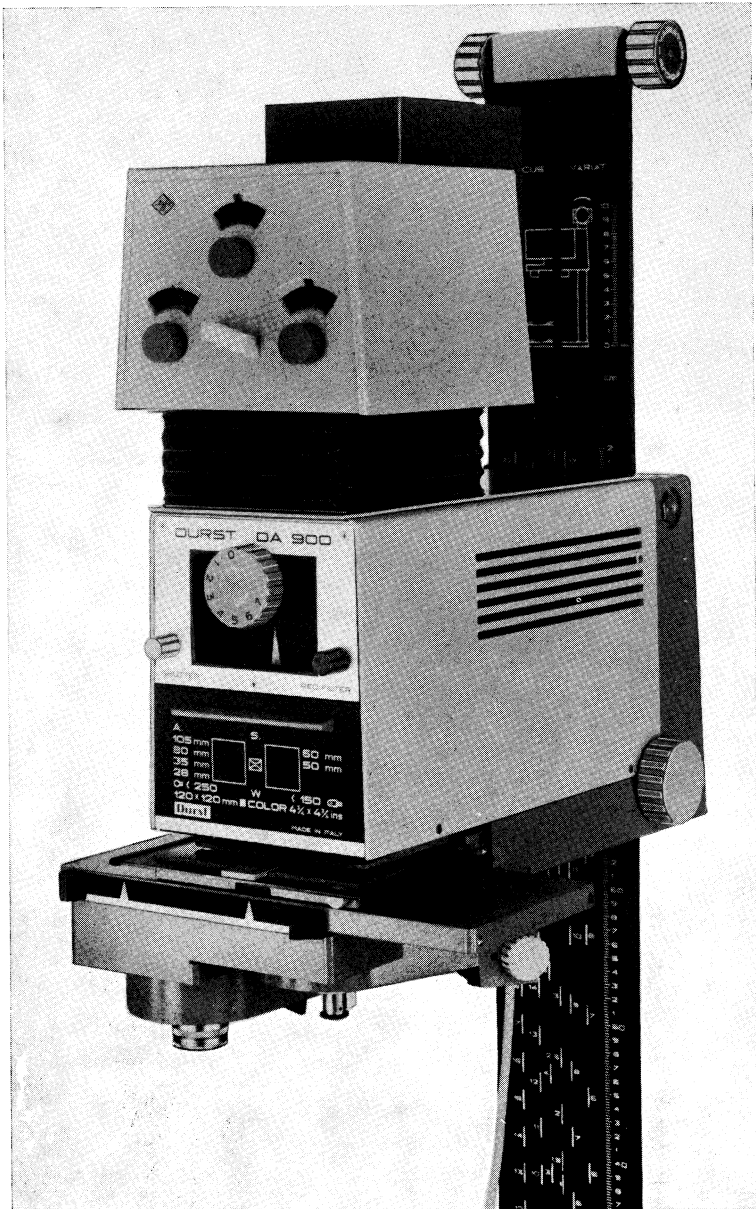

## Copying

For the DURST DA 900 copying equipment for plates and sheet films up to  $2\frac{1}{2} \times 3\frac{1}{2}$ " (6.5 x 9 cm.) is available separately. This consists of:

1. The URNOV copying cassette which consists of a closed frame with a ground glass screen. With the URNOV cassette come two plate holders and two sheet film inserts for the format  $2\frac{1}{2} \times 3\frac{1}{2}$ " (6.5 x 9 cm.). Reducing adapters for  $1\frac{3}{4} \times 2\frac{1}{4}$ " (4.5 x 6 cm.) plates and sheet film inserts for  $1\frac{3}{4} \times 2\frac{1}{4}$ " (4.5 x 6 cm.) are available as separate accessories. A guide rail is provided for inserting the cassette and opening the dark slide.

2. The RILU lighting unit: this consists of two hard-chromium steel lamp supporting bars. To use the RILU lighting unit, first fasten the two mounting clamps in the provided drilled holes of the base board. Proceed as follows: loose the two cross-slot screws (36), then lay the mounting clamps with their smooth side upwards over the two drilled holes on the base board. To fasten the mounting clamps use the two cross-slot screws (36) and the two screws delivered together with the RILU lighting unit. Then attach the two clamping sleeves to these. The height of the bars can be adjusted and locked with a clamping screw. On each bar are two individually controlled lights which can be slid along the rod and can be swiveled upwards. These take opal lamps of up to 150 W. Each light has a diffusing screen which provides even illumination of the original. By using colour or polarization filters special effects may be obtained. The lamp supporting bars can be tilted back when not in use so that they do not interfere with the enlarging work. For perfect illumination of originals of over  $12 \times 16$ " (30 x 40 cm.) format, the RILAR special extension arms are available as a separate accessory. These are placed between the two clamps on the base board (2) and the lamp supporting bars of the RILU.

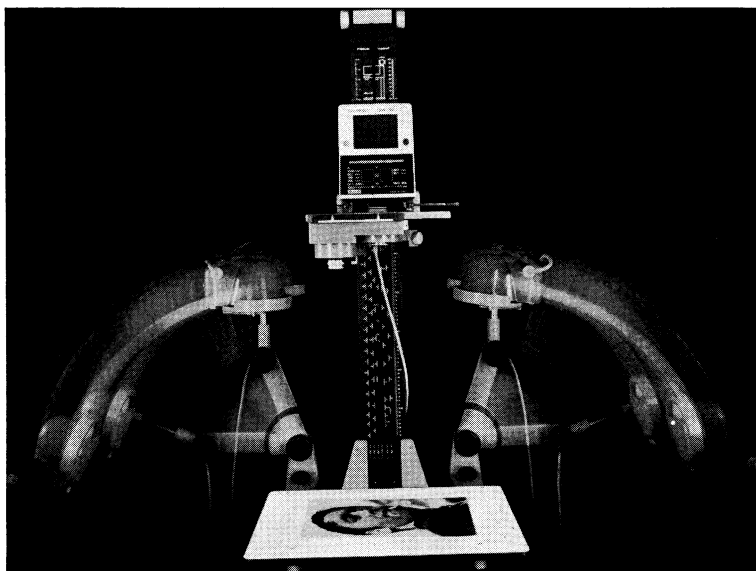

## Copying with the DURST DA 900

The URNOV copying cassette is inserted into the enlarger head (5) in place of the negative carrier and locked with the knurled knob. To control the focusing adjustment, project the crossed hairs of the ground glass screen upon the base board (2) at best with the enlarger head at its uppermost position. If the crossed hairs appear out of focus, adjust the height of the copying cassette by turning the knurled focusing ring at the front of the cassette either right or left. This is locked with a knurled screw which must be loosened before focusing and then tightened again afterwards. Then the copying cassette is adjusted once for all. The green filter (37) is removed and the mirror housing (7) inverted so that the mirror faces forwards. In the deflecting mirror you can view the usable projection area and by raising or lowering the enlarger head (5) the format net can be matched up with the original illuminated by the RILU unit. In doing this, make certain that the original,

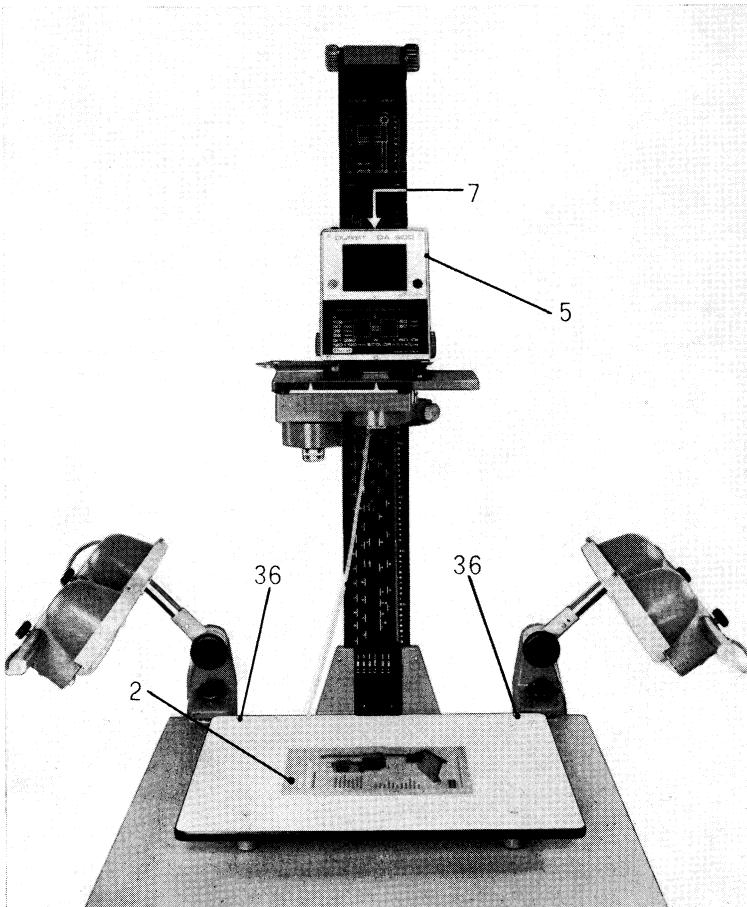

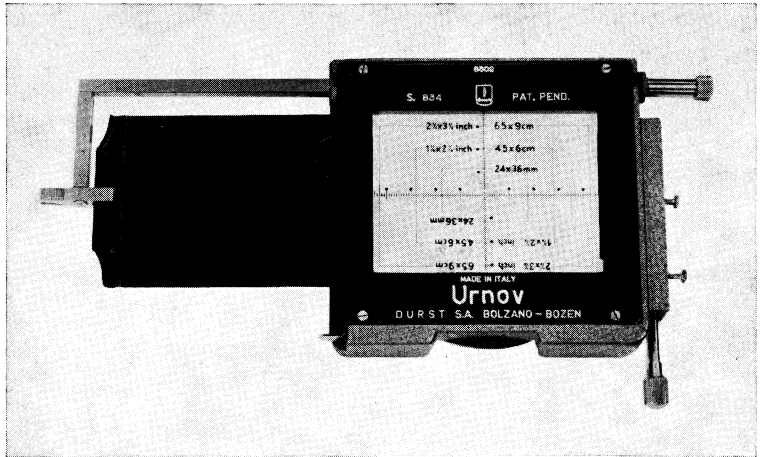

URNOV

as seen in the mirror, is absolutely free of reflection and evenly illuminated. The original is then exposed by switching the RILU lighting unit on and off.

### Maintenance

The DURST DA 900 is constructed for extreme requirements and requires a minimum of care. Even under unfavourable working conditions this enlarger retains its high capacity. The only care needed is that the steel bands (38) be wiped cautiously from time to time with an oily cloth. The negative carrier glasses, condensers, and the lenses are cleaned with a chamois, or even better with an anti-static brush or cloth to remove dust. All lenses have an anti-reflection coating, therefore handle and clean with utmost care to avoid scratches. To protect your DURST DA 900 against dust and darkroom dampness, you should cover it with the durable plastic AUTOCUF hood which can be ordered as a separate accessory.

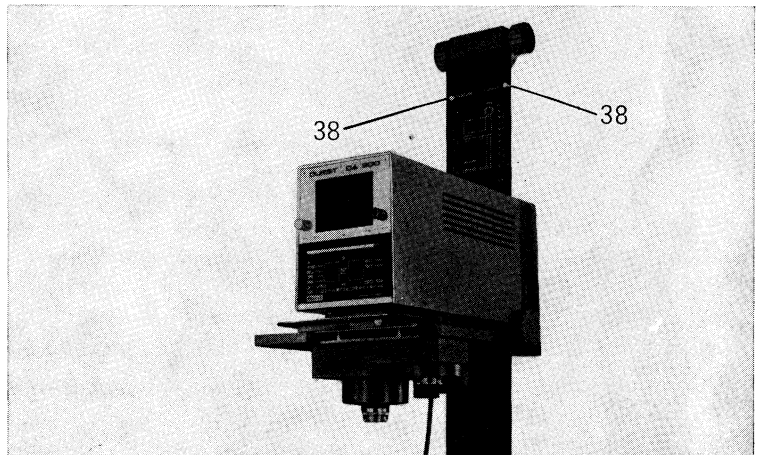

As you have noticed in reading these directions for use, the operation range of your DURST DA 900 can be expanded substantially by means of additional special accessories. The following list is meant to give you an overall view of the comprehensive and extensive accessory system with which you can take complete advantage of the versatility of your DURST DA 900:

**The special accessories system for the DURST DA 900**

- AUTOCUF protective hood  
(see page 20 « Maintenance »)
- AUTOFARB adapter  
(see page 17 « Colour enlargements »)
- AUTOCALO heat absorbing filter  
(see page 4 « Illumination »)
- DANOLI cold light unit  
(see page 5 « Illumination »)
- DUTUB and DUTUB II reduction tubes  
(see page 11 « Reductions »)
- RILAR extension arms  
(see page 18 « Copying »)
- RILU lighting unit  
(see page 18 « Copying »)
- URAN plate holder  
(see page 14 « Enlarging plates »)
- URNOV copying cassette  
(see page 18 « Copying »)

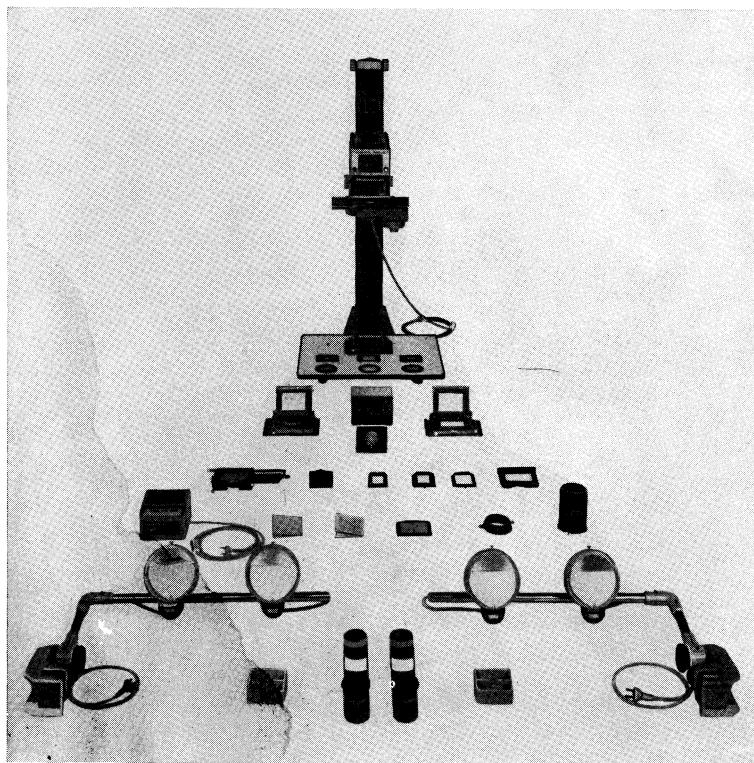

In addition to these accessories already mentioned in the directions for use, DURST also manufactures the following darkroom equipment which can make your darkroom work easier and more productive.

### **Enlarging easel DURST 243**

The DURST 243 enlarging easel saves the darkroom technician time and effort in setting the different formats. It consists of a darkroom-proof baked enamel cast frame with independently adjustable mask bands. With these and a paper stop which can be adjusted by means of a knurled knob, any desired margin width from  $\frac{3}{16}$ " to  $1\frac{3}{8}$ " (4 to 35 mm.) can be set.

Paper formats up to  $9\frac{1}{2} \times 12$ " (24 x 30 cm.) can be used. The frame is converted to inches simply by turning over the scales. For a slightly higher price this easel is also available with a plastic base board.

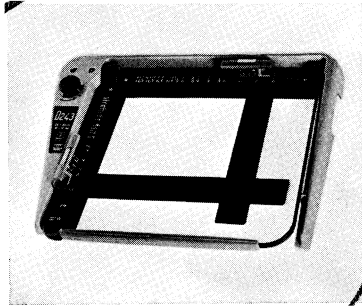

DURST 243

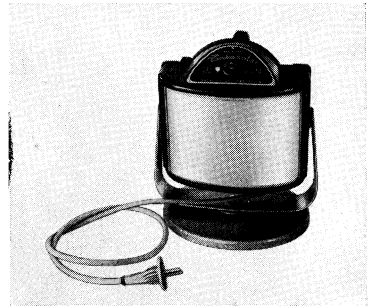

DURST PENCO

### **Darkroom light DURST PENTACOLOR**

The DURST PENTACOLOR darkroom light is equipped with five interchangeable filters: the first for white light, the others for the colours orange, ruby-red, olive-green, and pan-green. The filters are mounted in a turntable which allows easy setting of the desired illumination. A heat absorbing filter prevents bleaching of the colour filters. By tilting the housing, indirect illumination may be obtained. The light is either fixed to the wall or placed on the table.

### **Electronic exposure measuring and timer apparatus DURST TIM 100**

The electronic exposure measuring and timer apparatus DURST TIM 100 is a compact table model with a shock-proof plastic housing. Its electronic construction guarantees maximum measurement accuracy and exposure timing so that exposure mistakes are absolutely impossible. The measurement and timing circuits are mains stabilized and compensate completely for current oscillations of  $\pm 10\%$ . The measuring sensitiveness is extremely high even with weak light, it corresponds to an aperture value of  $\pm 1/4$ .

The exposure time range is very large and enables 25 different focusings from 1 to 250 seconds. The exposure times are logarithmically staged, 3 stages double the exposure time. The unit may be used with the following currents: 110V, 125V, 140V, 160V, 220V, and 240V (50 and 60 cycles). Thanks to its highest precision of measurement the TIM 100 is also well-suited for colour enlargements.

### **Voltage stabilizer DURST STABI**

The DURST STABI voltage stabilizer, available in models for 500W, 1000W, and 2000W, is indispensable, especially during colour work, to avoid false exposures during frequent current oscillations. The



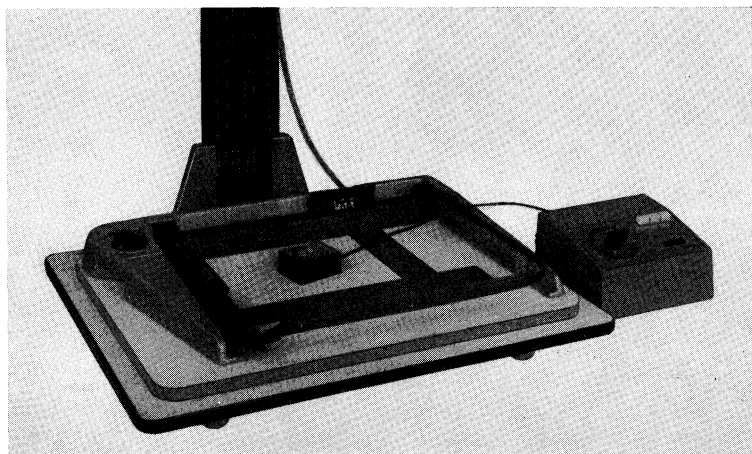

DURST TIM 100

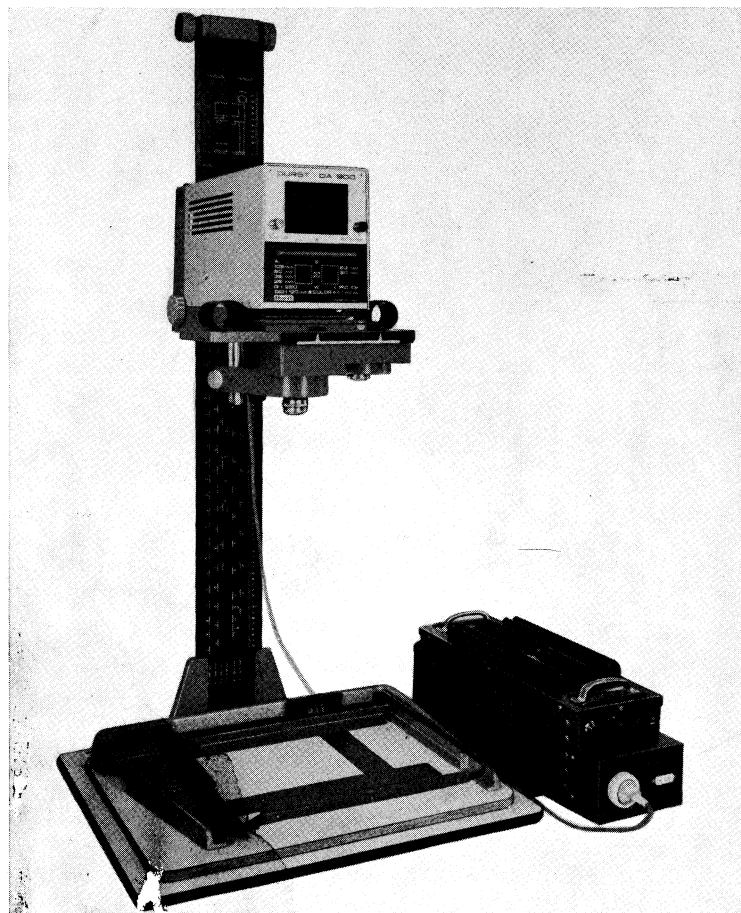

DA 900+ Stabi

DURST STABI voltage stabilizers attain stabilization exactness of  $\pm 2\%$  and are available for 110V, 160V, and 220V feeding voltage; output voltage and frequency as specified with the order.

**Test negatives**

Check the quality of your lenses with our test negatives which are available separately, and which can also be used for checking the focus during manual focusing.

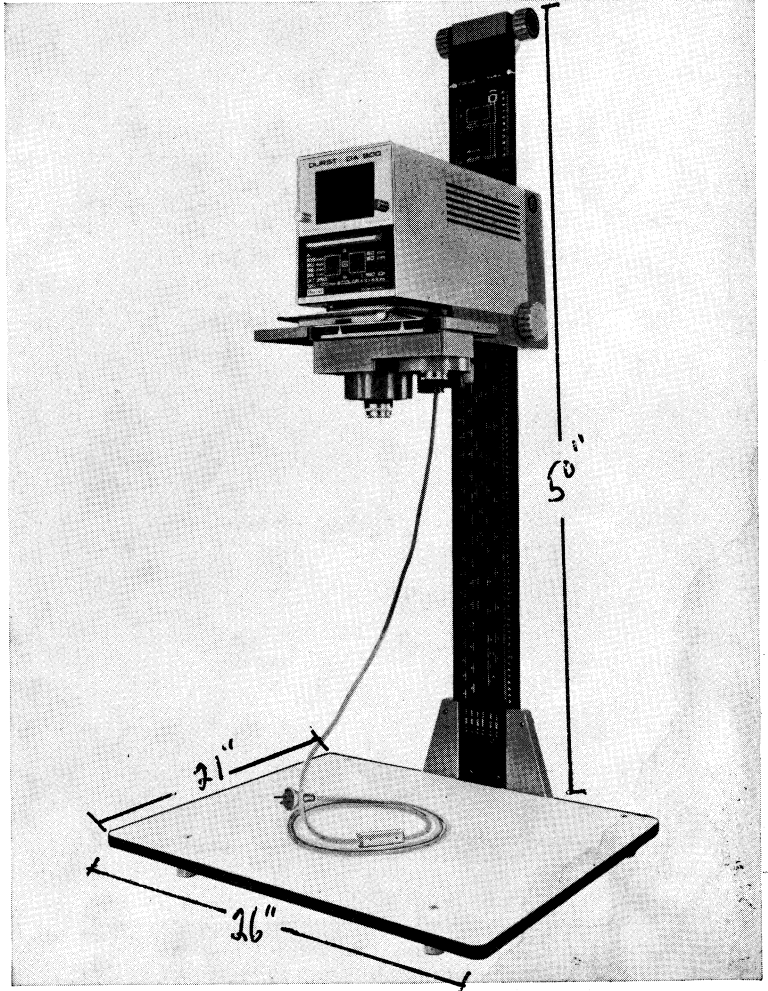



# Durst<sup>®</sup>

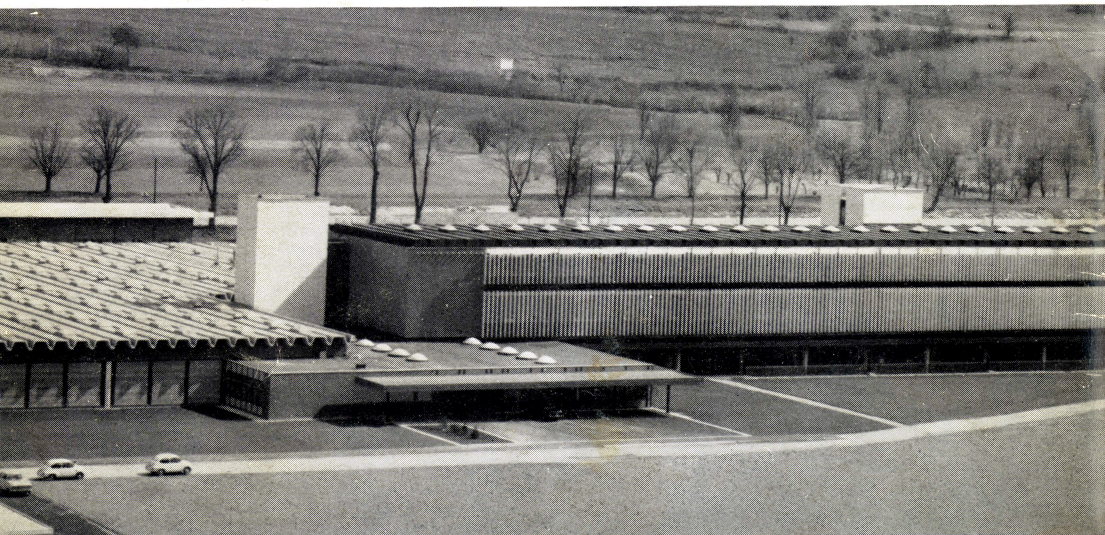

**Durst Inc. 39100 Bolzano Italy - P. O. Box 445**